



A COMPLETE FAMILY OF FIRE SUPPRESSION SYSTEMS
SOLUTION FOR MINING & MOBILE EQUIPMENTS



FIRE SUPPRESSION SYSTEMS



Cylinder Valve LOP

- Solid brass valve, chrome plated for additional corrosion resistance

Manual Actuator

- For manual actuation, available in two size for internal and external vehicle mounting



Cylinder Bracket

- Heavy duty cylinder brackets
- Protect and hold cylinder fire in static mode



Foam Cylinder Assembly

- 3 cylinder size : 85L, 50L, 35L
- Stainless steel construction
- Heavy duty cylinder

Discharge Line

- Corrosion resistant stainless steel discharge line

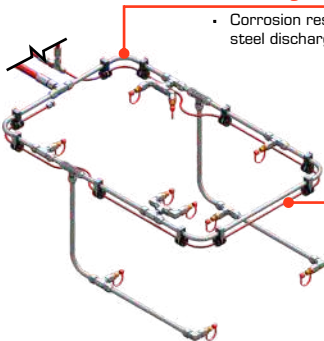

Fire Panel Alarm



- Monitoring the status of the system and provide audible and visual indication











Detection Line

- As Heat detector for automatic activation, which is active along its entire length. Melts when heated to in excess of 130°C - 150°C





Ordering Information





			
CYLINDER FIRE HC 106	CYLINDER FIRE HC 65	CYLINDER FIRE HC 45	CYLINDER HEAD VALVE LOP
PN: 834461503 (CYL ASSY & BRACKET)	PN: 834461403 (CYL ASSY & BRACKET)	PN: 834461303 (CYL ASSY & BRACKET)	PN: 83446101L
PN: 834461500 (CYL ASSY)	PN: 834461400 (CYL ASSY)	PN: 834461300 (CYL ASSY)	
PN: 834061012 (CYL BRACKET)	PN: 834061011 (CYL BRACKET)	PN: 834061011 (CYL BRACKET)	





			
HARTEX FIRE PANEL ALARM with ES	MANUAL LOP ACTUATOR	PRESSURE SWITCH	FLEXIBLE SYPHON TUBE
PN: 834011011 (ALL PANEL ASSY)	PN: 834471010E (EXTERNAL/LARGE)	PN: 834011015 (PRESSURE SWITCH)	PN: 834061512 (HC 106)
PN: 800001017 (CONNECTOR 12 PINS)	PN: 834471010I (INTERNAL/SMALL)	PN: 800001406 (PLUG CONNECTOR 2 PIN)	PN: 834061412 (HC 65)
			PN: 834061312 (HC 45)

			
RUBBER CLAMP	CYLINDER BRACKET MOUNT	AFFF C6 FOAM	RUBBER GROMET
PN: 834061017 (2 METERS/BRACKET)	PN: 800001035 (WELD MOUNT)	PN: 834061010 (1 LTR)	PN: 834471017 (CYL ASSY & BRACKET)
	PN: 834061018 (RUBBER MOUNT)		





Ordering Information





			
NOZZLE KIT SINGLE 90° END	NOZZLE BM 17N-60°	NOZZLE BM 16W-120°	FIRE DETECTION TUBING
PN: 834071018	PN: 834071014	PN: 834071015	PN: 834471300 (DETECTION TUBING) PN: 834471013 (COUPLING ASSY)

			
NOZZLE KIT DOUBLE STRAIGHT 90°/90°	NOZZLE KIT DOUBLE 90°/45°	NOZZLE KIT SINGLE ANGLE	NOZZLE KIT SINGLE STRAIGHT
PN: 834071020	PN: 834071021	PN: 834071019	PN: 834071017

			
FIRE MASTER 1SN	BOLTED 1/2" TUBE CLAMP	P-CLAMP	NOZZLE CAP
PN: 04-1SNFSS (SIZE 1/4")	PN: 834071010	PN: 800001028 (1/8" OR 3/16" HOSE)	PN: 834071016
PN: 08-1SNFSS (SIZE 1/2")		PN: 800001029 (1/2" HOSE)	
PN: 12-1SNFSS (SIZE 3/4")		PN: 800001030 (3/4" HOSE)	

Ordering Information

			
STAINLESS TUBING 1/2"	STRAIGHT ADAPTOR JIC	BULKHEAD ADAPTOR	UNION TEE ADAPTOR
PN: 834071011 (SS TUBING 1/2")	PN: 0502525-04-04 (7/16")	PN: 0502523-04-04 (7/16")	PN: 0702525-04-04 (7/16")
PN: 834071013 (SLEEVE NUT JIC 3/4")	PN: 0502525-08-08 (3/4")	PN: 0502523-08-08 (3/4")	PN: 0702525-08-08 (3/4")
	PN: 0502525-12-12 (1.1/16")	PN: 0502523-12-12 (1.1/16")	PN: 0702525-12-12 (1.1/16")

			
FITTING STRAIGHT JIC	FITTING 45 JIC	FITTING 90 JIC	FERRULE
PN : 022512-04-04 (1/4" - 7/16")	PN : 022542-04-04 (1/4" - 7/16")	PN : 022592-04-04 (1/4" - 7/16")	PN : 003400-04 (SIZE 1/4")
PN : 022512-08-08 (1/2" - 3/4")	PN : 022542-08-08 (1/2" - 3/4")	PN : 022592-08-08 (1/2" - 3/4")	PN : 003400-08 (SIZE 1/2")
PN : 022512-12-12 (3/4" - 11/16")	PN : 022542-12-12 (3/4" - 11/16")	PN : 022592-12-12 (3/4" - 11/16")	PN : 003400-12 (SIZE 3/4")

CABLE TIE
PN: 870351201 (4.8 x 200)
PN: 870351202 (4.8 x 370)



REV. 21 FEB 2025

Distributor :

HARTEX GLOBAL INDUSTRIAL

Factory :

Green Sedayu Bizpark Cakung Blok GS 5 No. 102
Jl. Cakung Cilincing Timur Raya KM. 2
Cakung - Jakarta Timur - 13910

☎ : +62 21 461 3110 | 📞 : +62 811 803 6799
Email: info@hartex.id | Web: www.hartex.id